

SPECIFICATION SHEET
PLATO 750 1 DRAW WALL HUNG SOLID SURFACE TOP

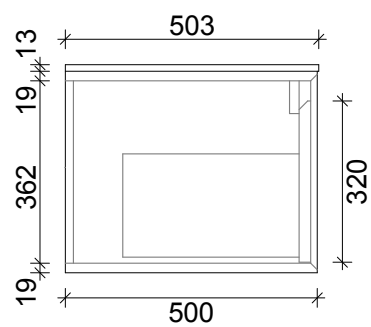
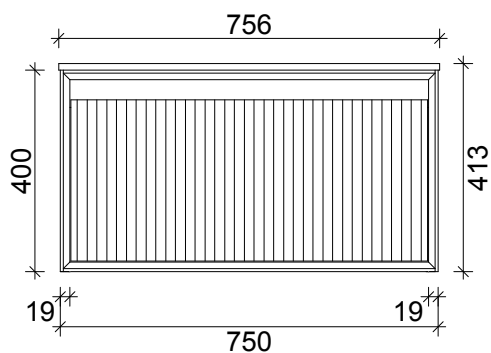
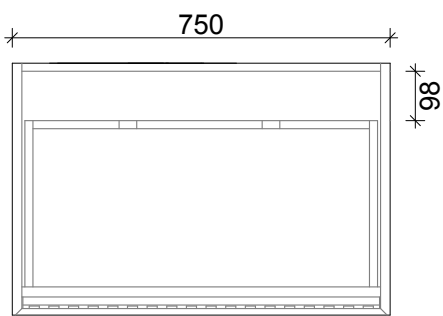

PRIMO BATHROOMWARE
3 EDISON PLACE
(03) 384-2471
EMAIL: enquiries@primobathroomware.co.nz