

Front Elevation

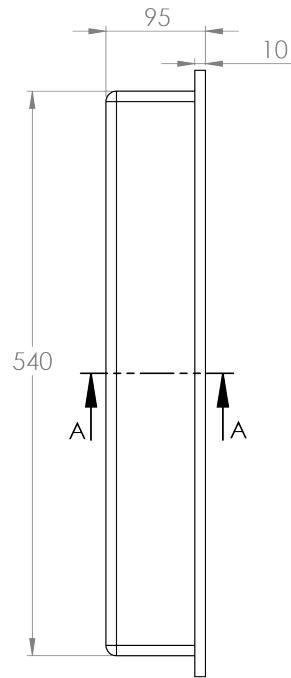

Plan View

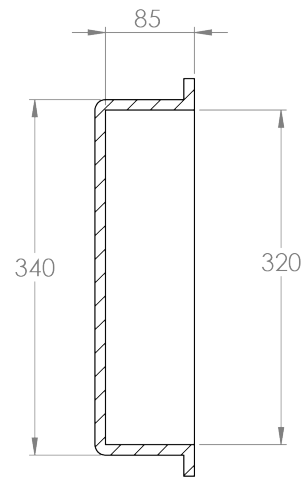

SECTION A-A

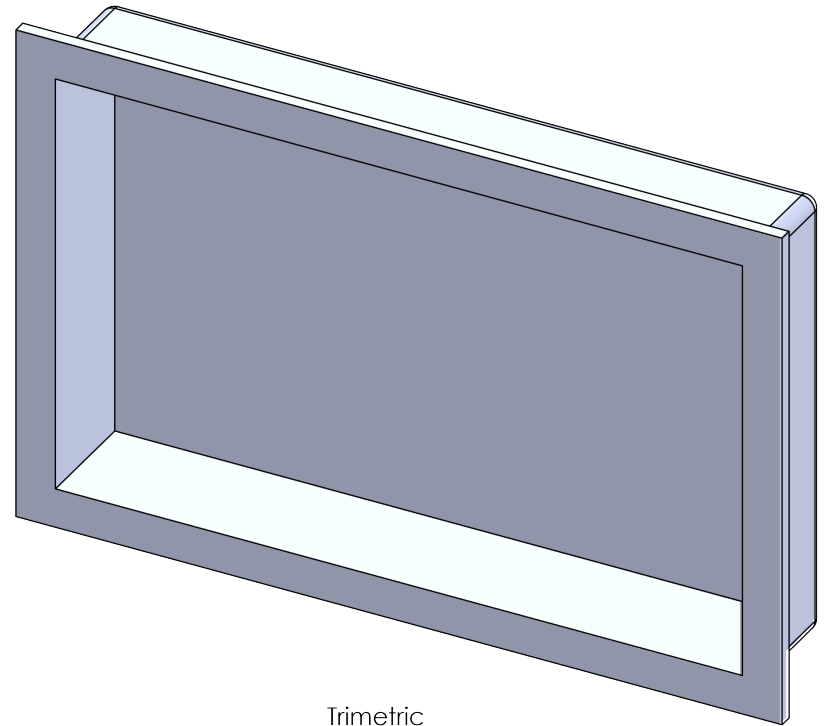

Trimetric

crest
showers

WN520
WALL NICHE 520 X 320