

# SPECIFICATION SHEET

## Porscha 1200 2-Drawer Double Basin Wall Hung Vanity



### Features

- 2-Drawer Wall Hung Vanity - Colour options below
- StoneCast 20mm Via Basin [Standard] - Upgrade options available
- Full Extension Soft Close Drawers with Extrusions - Extrusion upgrade options available
- Designer Drawer Fronts - Four Drawer Front options
- Dimensions: H400 x W1190 x D453

### Cabinet Options

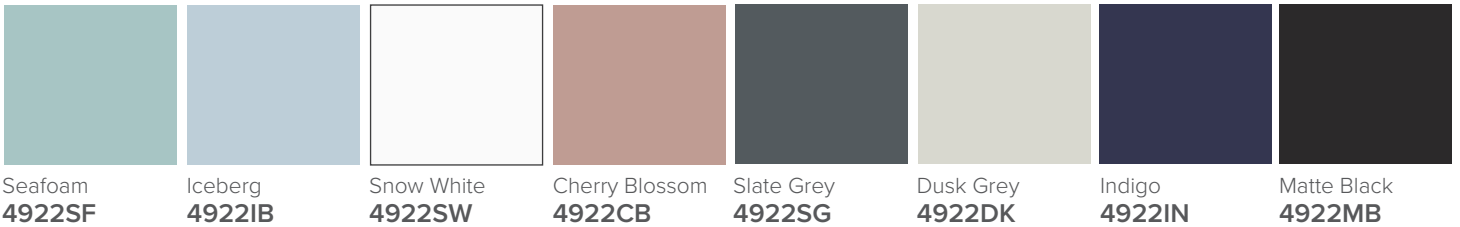

### Technical Details

Note: All measurements shown are in millimetres. Sizes are nominal.

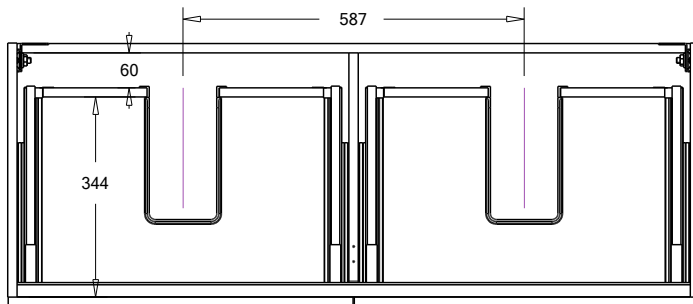

TOP VIEW

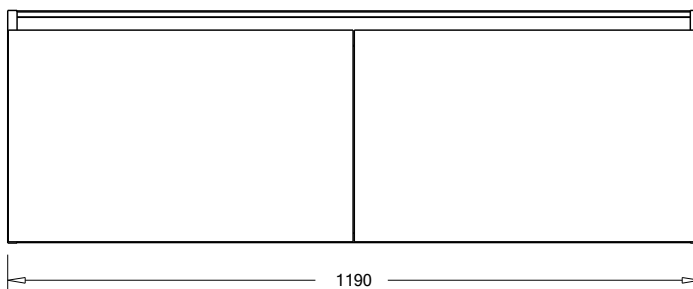
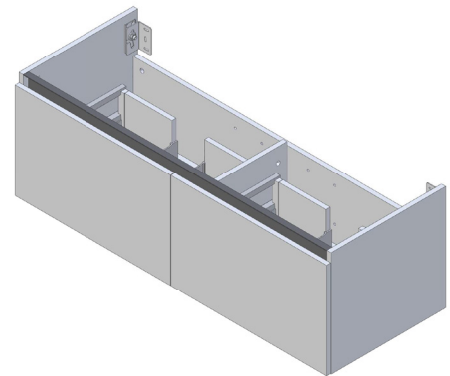

FRONT VIEW



SIDE VIEW

# SPECIFICATION SHEET

## Porscha Designer Drawer Fronts

BARNSLEY  
18mm Inset Frame  
Code: BL

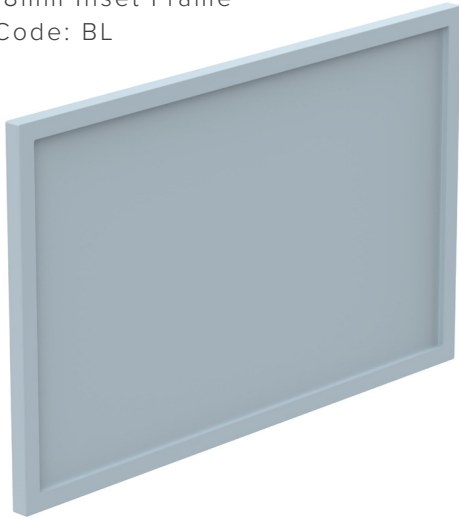

PRESTON  
60mm Inset Frame  
Code: PT

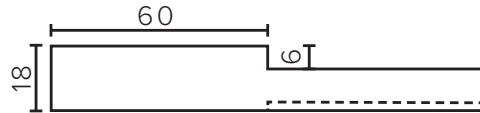
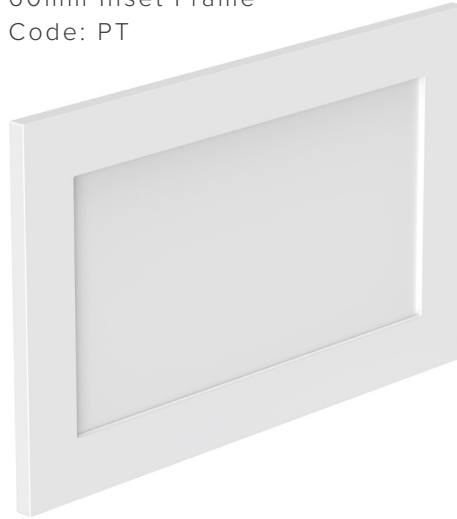

TURNBERRY  
Ripple Design Panel  
Code: TB

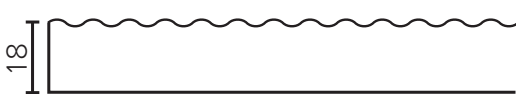
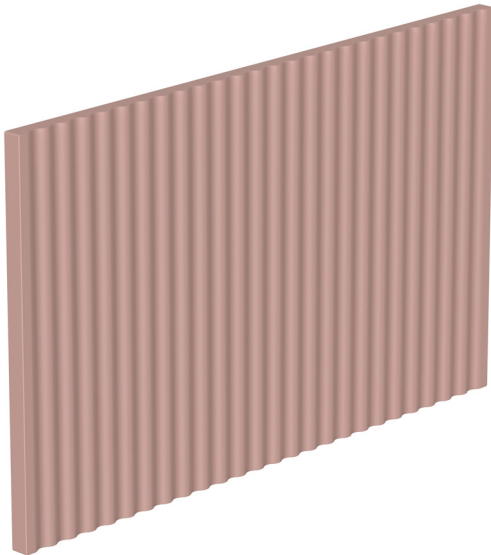

NEWPORT  
V-Groove Panels  
Code: NP

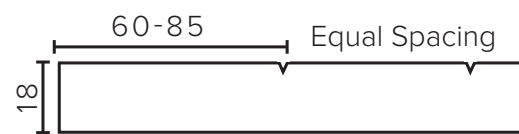
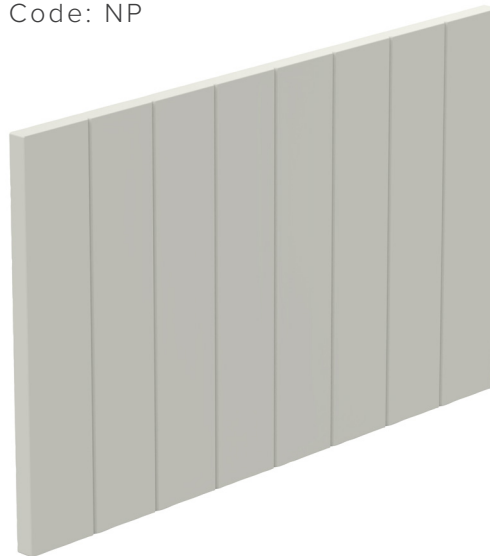

Seafoam



Iceberg

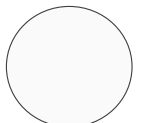

Snow White



Cherry Blossom



Slate Grey



Dusk Grey



Indigo



Matte Black

# SPECIFICATION SHEET

## 1200mm Double Basin Options

### Via

StoneCast with overflow  
 Gloss White - VIA  
 Matte White - VIAMW

W1210 x D460 x H20

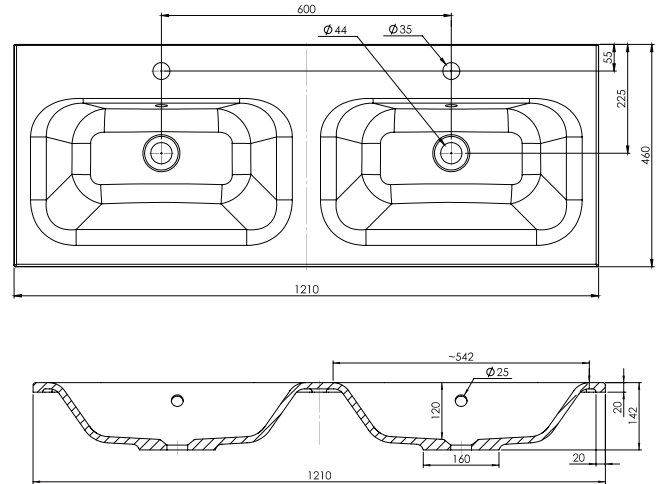
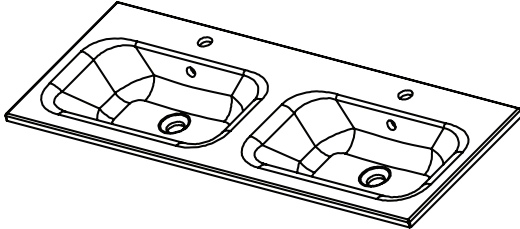

### Clasico

Vitreous China with overflow  
 Gloss White - VC

W1210 x D465 x H20

