

SPECIFICATION SHEET

Francisco Luxe 900 2-Drawer Wall Hung Vanity



Features

- 2-Drawer Wall Hung Vanity - *Colour options below*
- Full Extension Soft Close Drawers with Handles - *Handle upgrade options available*
- Designer Drawer Fronts - *Four Drawer Front options*
- Dimensions: H670 x W900 x D465
- Slab Top Options:
20mm StoneCast Top or Quartz Slab Top

*Note: Vessel basins are purchased separately.
Visit www.newtech.co.nz for the full range of vessel basin options.*

Cabinet Options

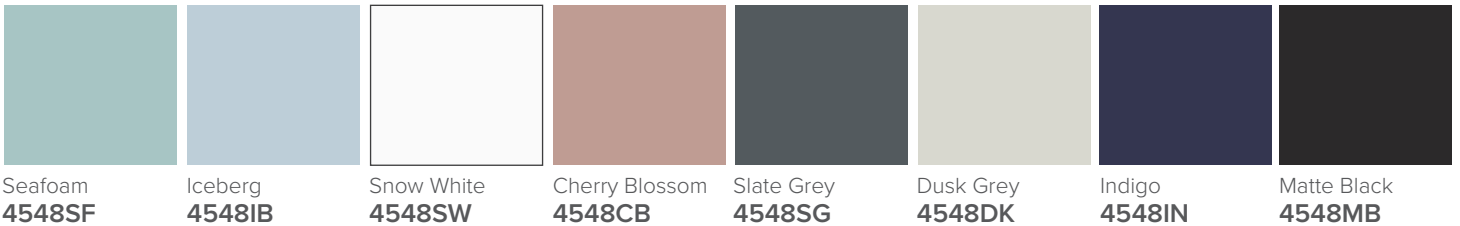

StoneCast Slab Top Options



Quartz Slab Top Options

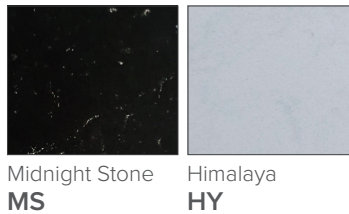

Note: To order a Slab Top, add the Slab Top code to the cabinet code

Technical Details

Note: All measurements shown are in millimetres. Sizes are nominal.

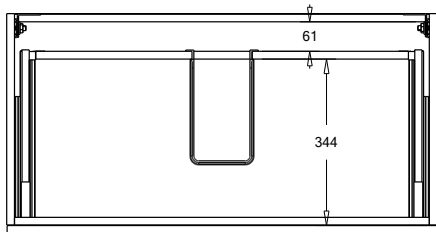

TOP VIEW

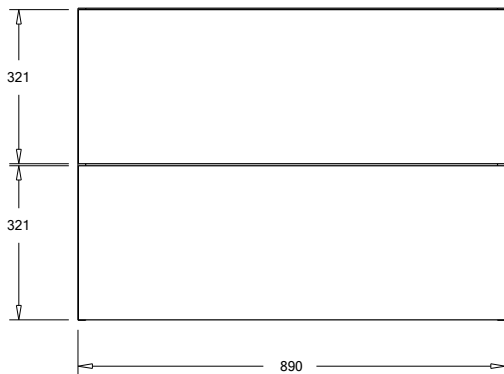

FRONT VIEW

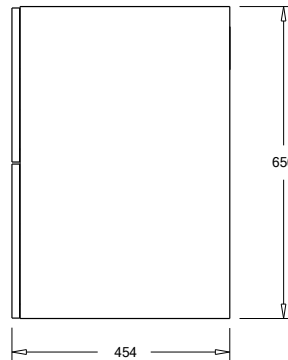

SIDE VIEW

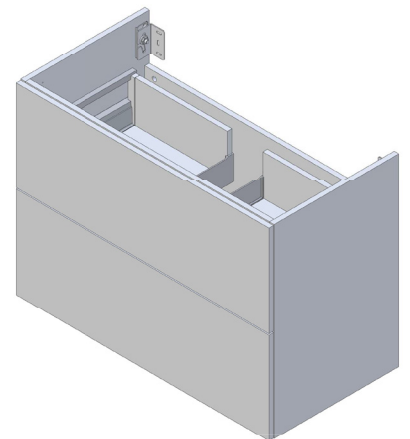

SPECIFICATION SHEET

Francisco Luxe Designer Drawer Fronts

BARNESLEY
18mm Inset Frame
Code: BL

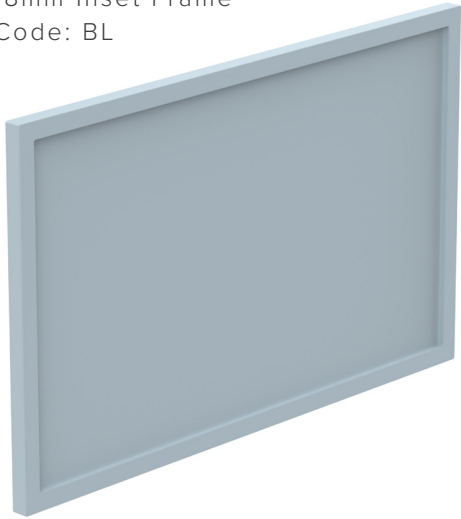

PRESTON
60mm Inset Frame
Code: PT



TURNBERRY
Ripple Design Panel
Code: TB

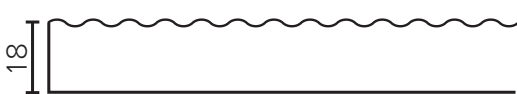

NEWPORT
V-Groove Panels
Code: NP



Seafoam



Iceberg



Snow White



Cherry Blossom



Slate Grey



Dusk Grey



Indigo



Matte Black