

SPECIFICATION SHEET

Arc 1200mm 2 Door, 2 Drawer Double Basin Wall Hung Vanity



Features

- Wall Hung
- Soft Close Doors & Drawers
- Negative detail finger pull
- Cabinet:
Laminate Woodgrain &
Solid Colours on MR Board
- Slab Top Options:
20mm Quartz Top or StoneCast Top
- Dimensions: H670 x W1200 x D465

*Note: Vessel basins are purchased separately.
Visit www.newtech.co.nz for full range of vessel basin options.*

Colour Options with Code

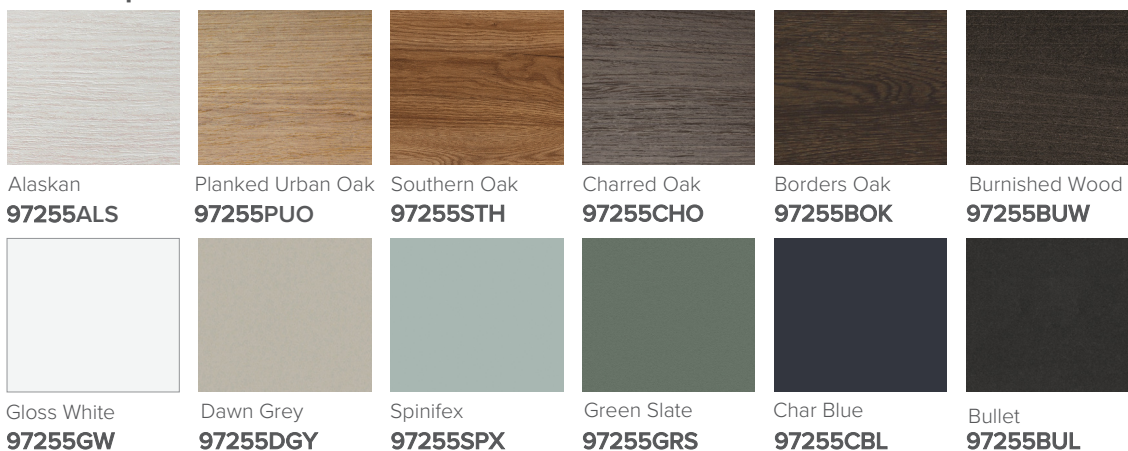

Technical Details

Note: All measurements shown are in millimetres. Sizes are nominal.

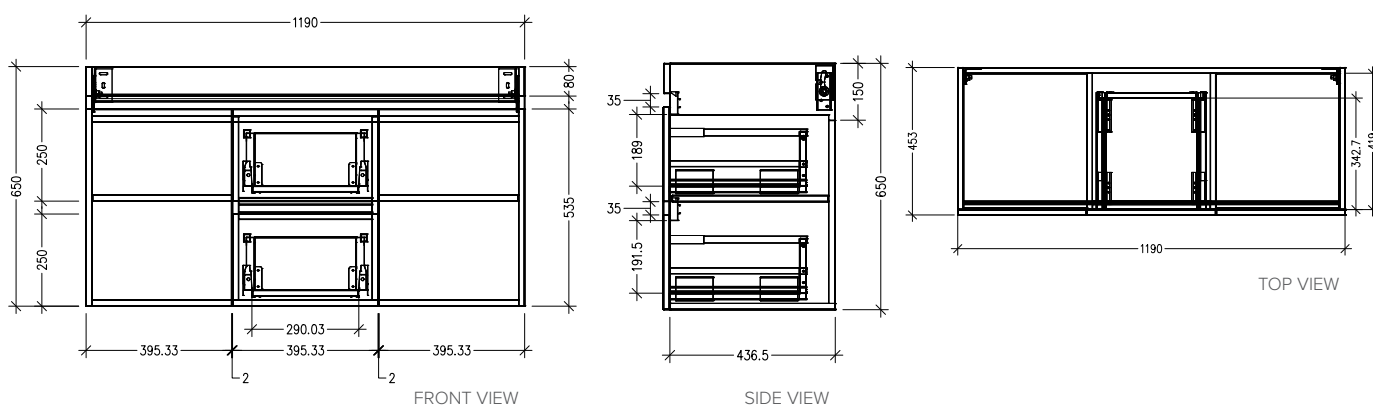

SPECIFICATION SHEET

Slab Top Options

StoneCast Slab Top 1200

W1200 x D465 x H20

Gloss White - SC

Matte White - SCMW

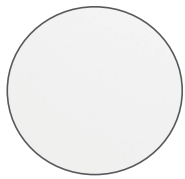
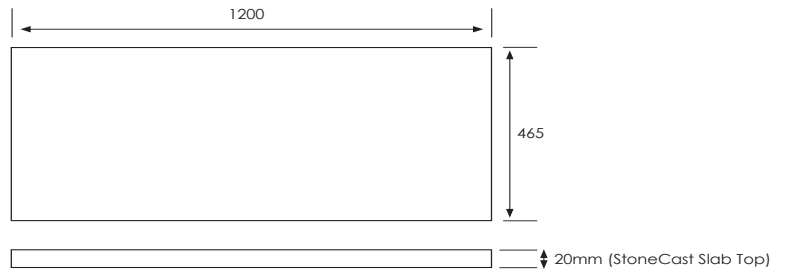
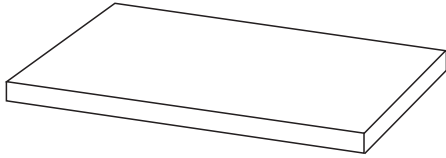

Gloss White



Matte White

Quartz Slab Top 1200

W1200 x D465 x H20

Midnight Stone - MS

Himalaya - HY

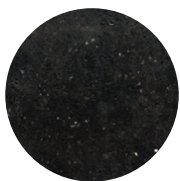
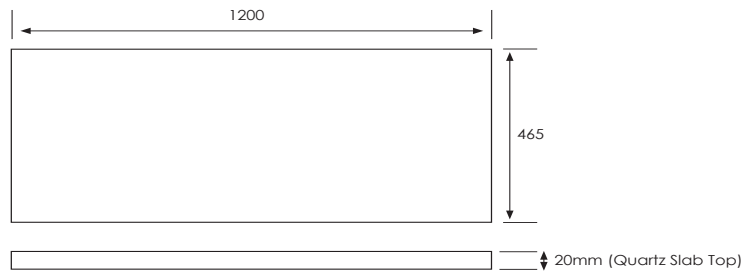
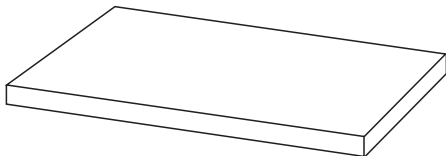

Midnight Stone

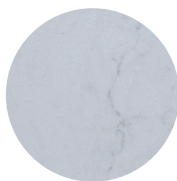

Himalaya

Tap Hole Position

Tap hole position must be specified

- NTH** No Tap Holes
- CTH** Centre Tap Holes
- LTH** Left Tap Holes
- RTH** Right Tap Holes
- ITH*** Inside Tap Holes
- OTH*** Outside Tap Holes

*only applicable with double basins